

Handwriting Alphabet Cards



**A choice of lower and upper case letters
each showing correct letter formation. Versions available for
letters to either start on the line or at the top of each letter.**

**Each card 70mm x 99mm
Supplied on A4 sheet to cut yourself**

Written and published by **KBER
Kath Balcombe (Educational Resources)**

Acknowledgements

The author would like to thank all those colleagues, pupils, and friends who have helped in the evolution of this book.

Kath Balcombe was born in Blackburn in 1958. She attended Derby Lonsdale College and qualified as a teacher with BEd (Hons) in 1982. She gained her C.F.P.S. (Specific Learning Difficulties) in 1993, and is an experienced teacher of pupils with dyslexia.

Handwriting Alphabet Cards

© Kath Balcombe 1998 - 2002

All rights reserved. This book is sold subject to the condition that it shall not, by way of trade use, be lent, hired, or copied *in any way*, for resale, or otherwise circulated, without the express permission of the author. All pages in this book may be photocopied for educational purposes *only* within the purchasing school or other establishment where the pupils are taught.

Also available by the same author:

A Reference for Spelling (Photocopy Masters) Tutor's version - Colour-coded phonic reference. **Printable version also available on CD-Rom.**

A Personal Spelling Sampler (Photocopy Masters) Pupil's version - Colour-coded phonic reference. **Printable version also available on CD-Rom.**

Make Spellings Stick (Photocopy Masters) using the Look - Learn - Say - Cover - Write - Check - Method.

Handwriting for Windows (3.5" Diskette for PC - Windows '95) font and special utility for converting any text to simulated handwriting with correct joins with choice of style, size and colour.

The Handwriting Alphabet File (Photocopy Masters) Choose from different lower case letter forms and upper case letters to suit your style. One letter per A4 sheet. Arrows showing how to form the letters. A4 durable card. Either with or without entry strokes. **Printable versions also available on CD-Rom.**

The Handwriting File (Photocopy Masters) A4 Information and practice book for handwriting. Individual letter, letter strings, whole word and text practice. Special unique shaded paper in different sizes. Available with or without entry strokes to letters. **Printable versions also available on CD-Rom.**

KBER (Kath Balcombe , Educational Resources)
10, Collingwood Drive
Bowbrook,
Shrewsbury.
SY3 5HP

Tel: 01743 356764 Fax: 01743 340062
Email: kath@kber.co.uk www.kber.co.uk

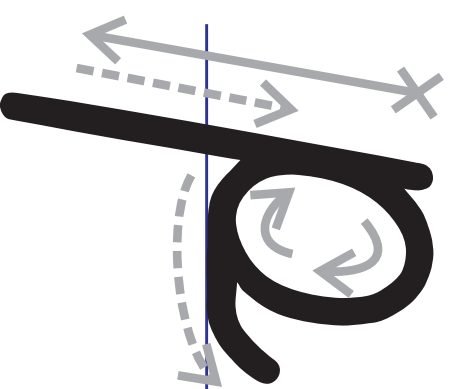
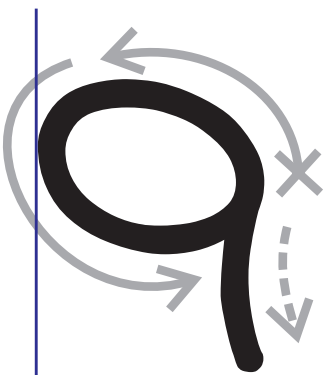
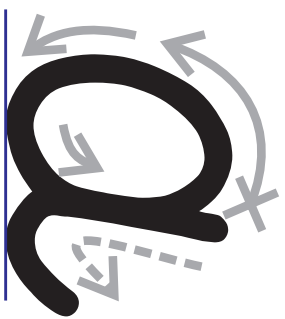

+

+

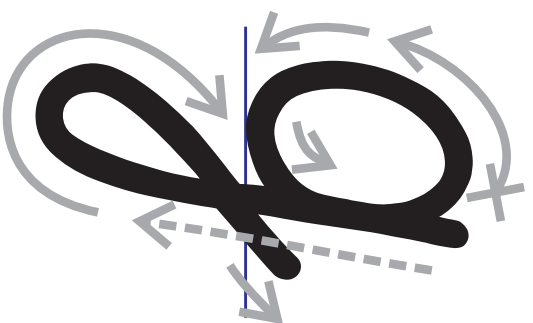
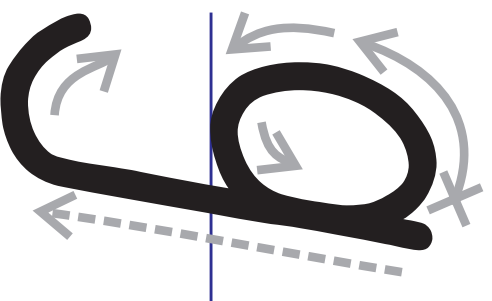

+

+

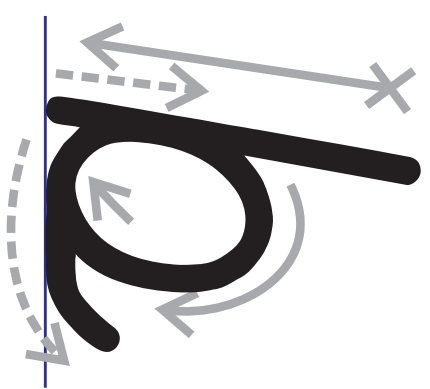
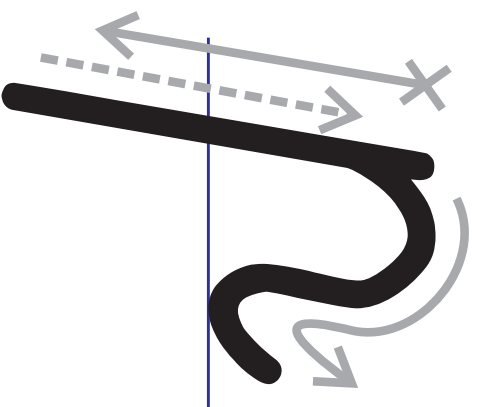
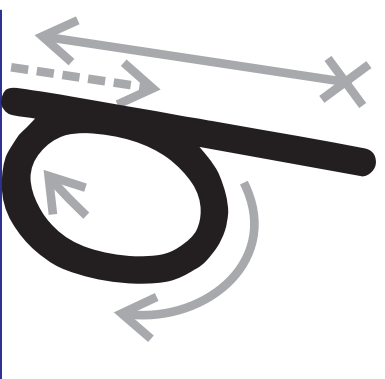

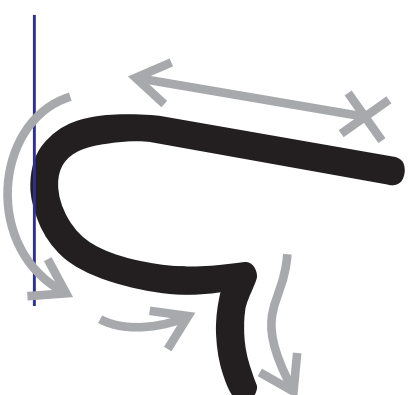
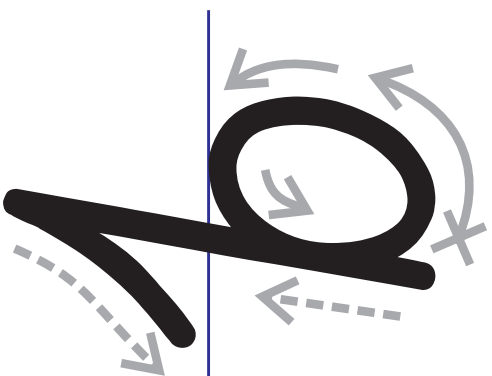
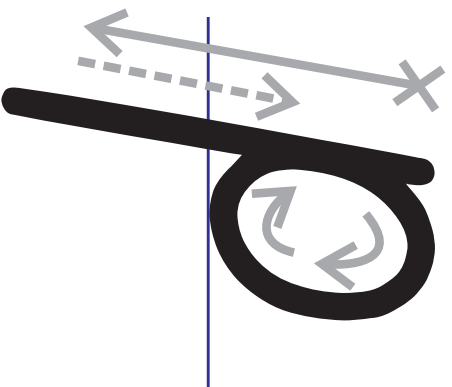
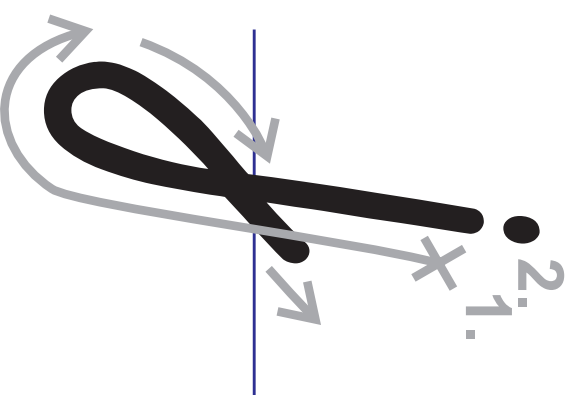
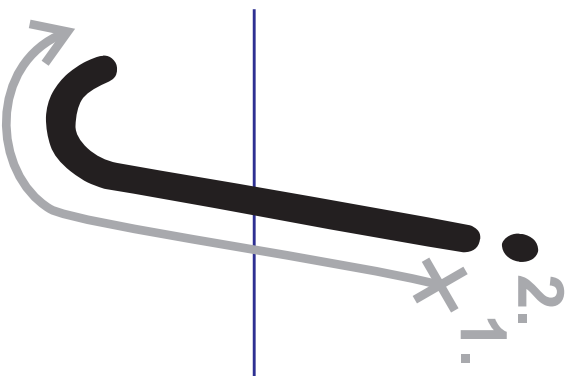
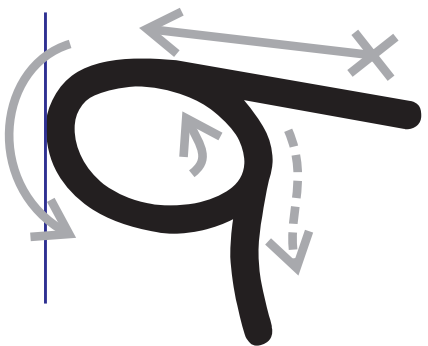
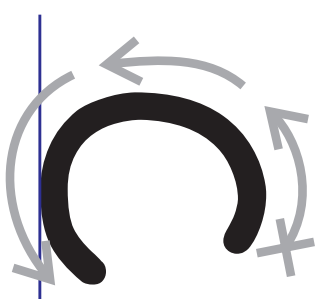
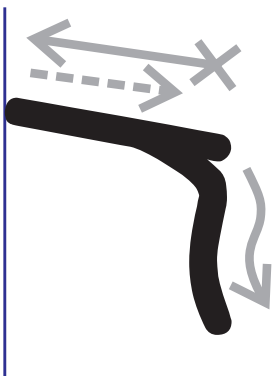
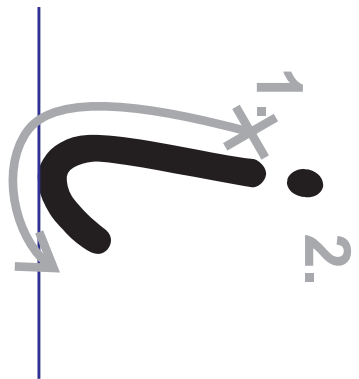

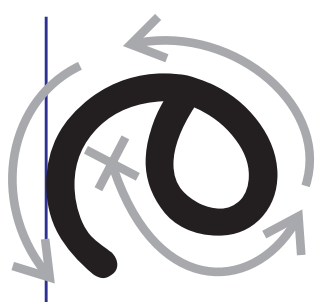
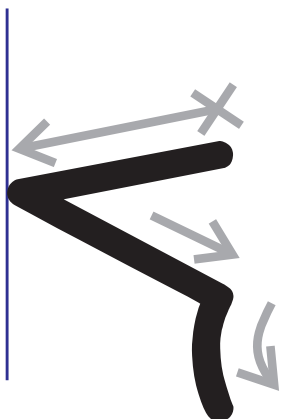
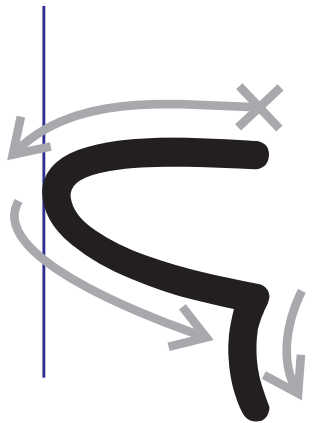

+

+

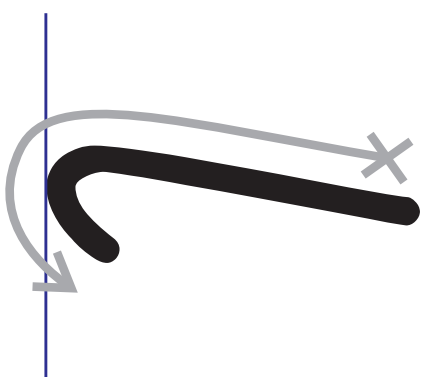
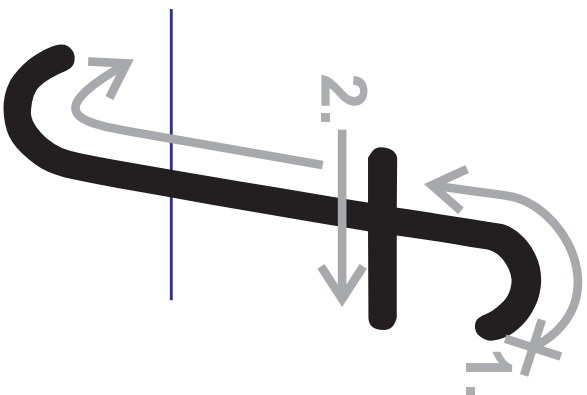
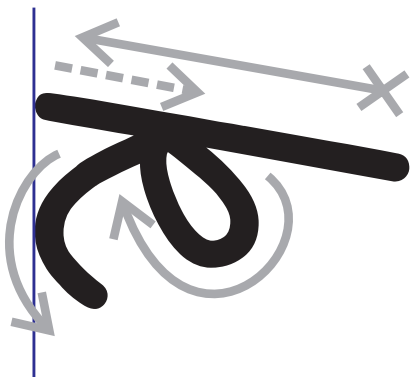

+

+

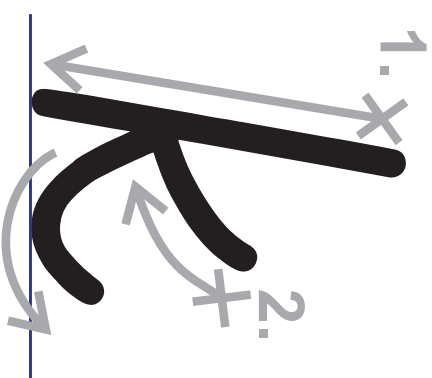
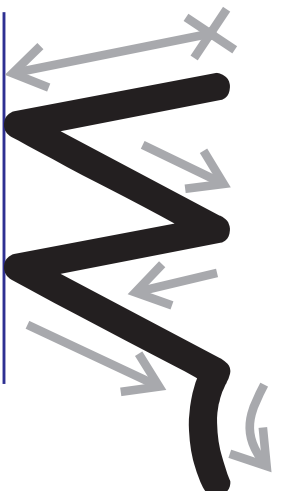
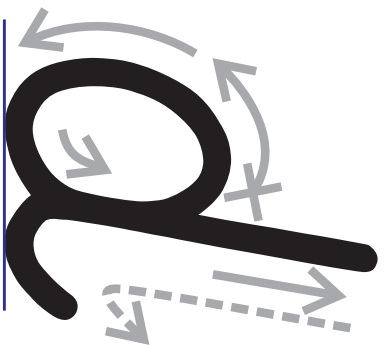

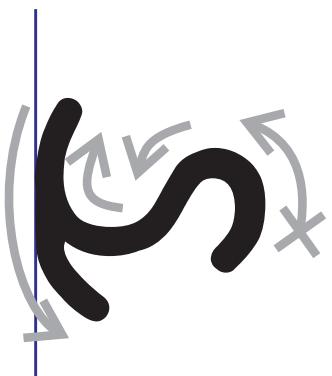
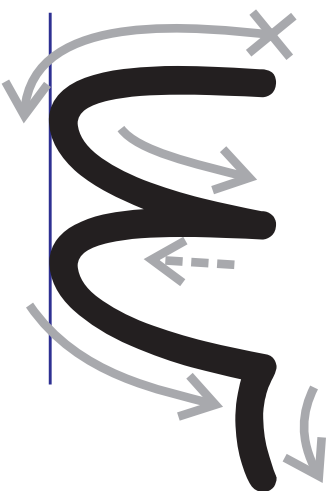
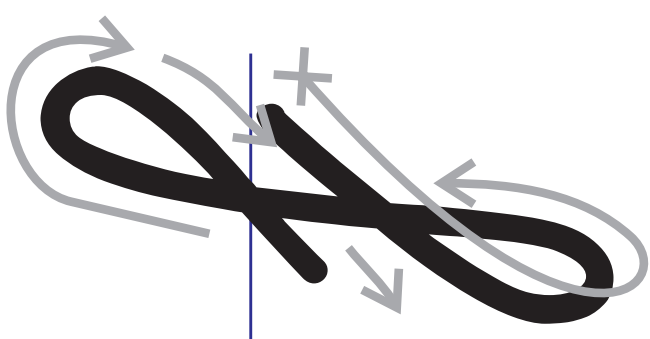
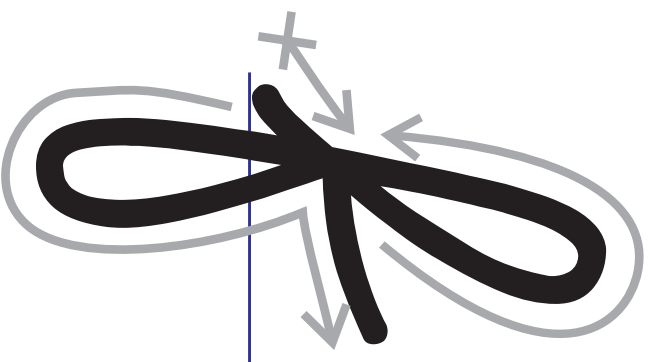
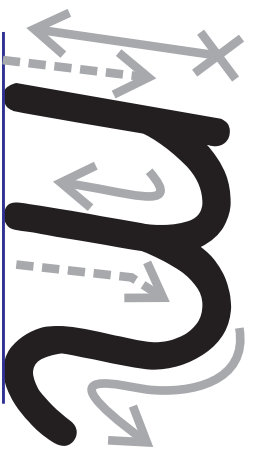
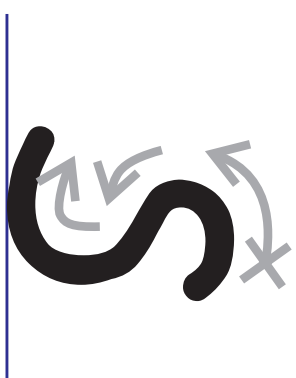
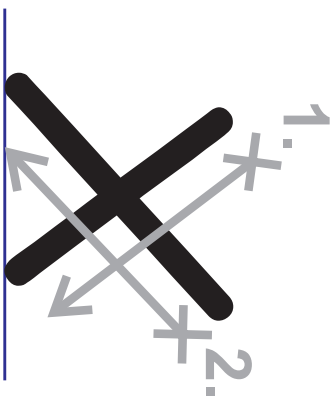

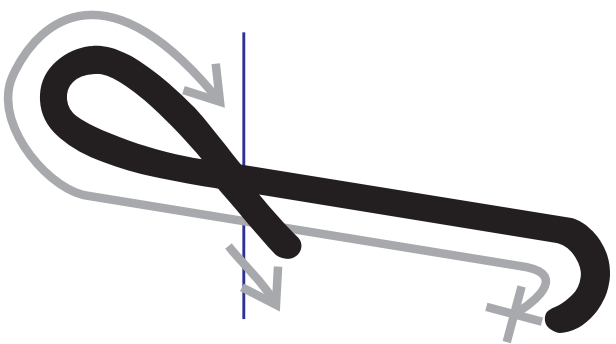

+

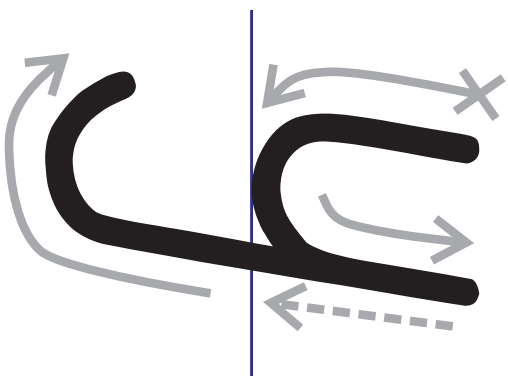

+

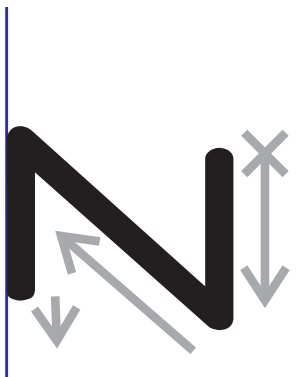
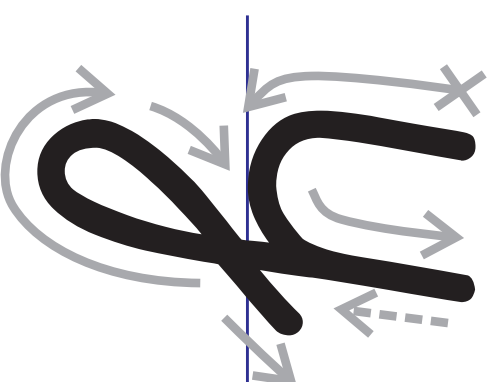

+

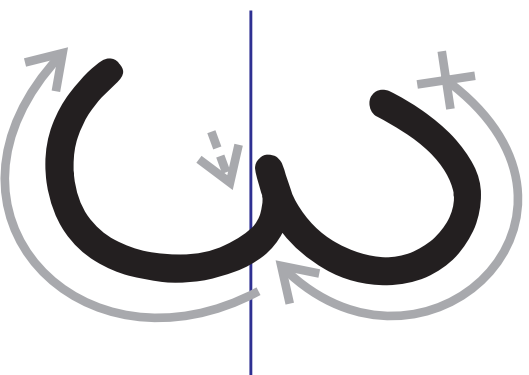

+

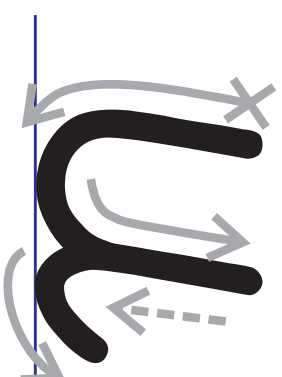
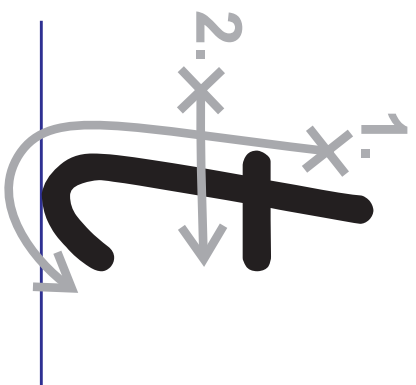
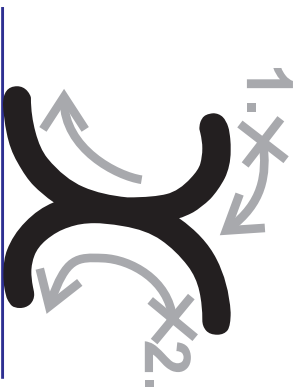
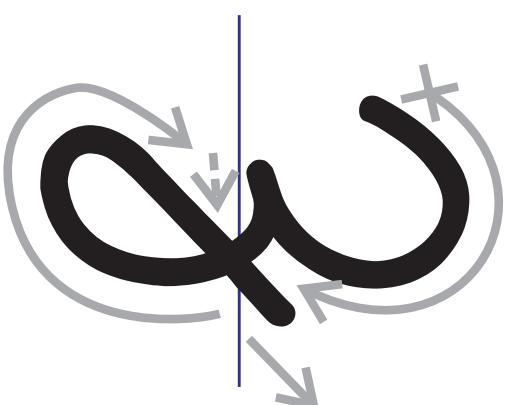

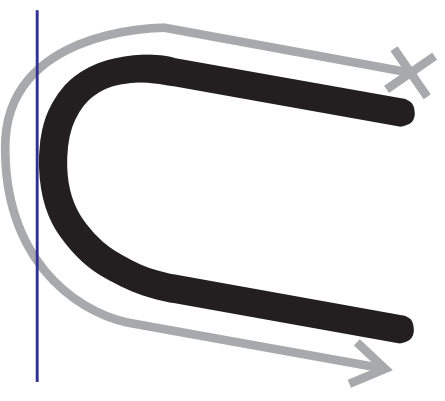
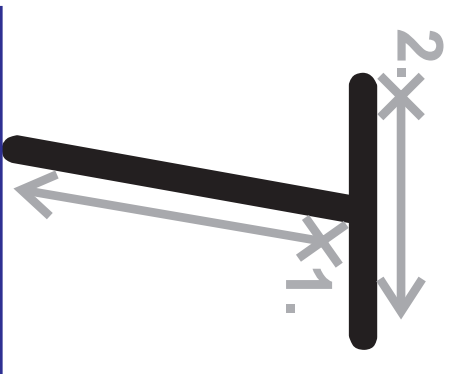
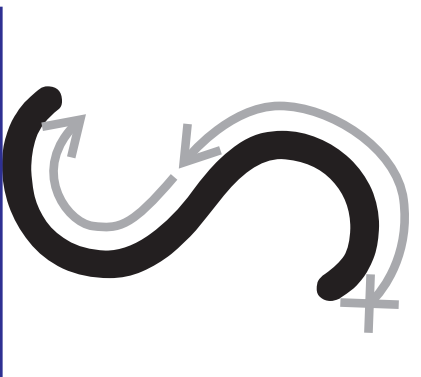
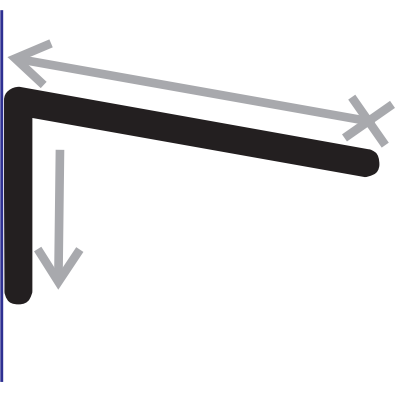
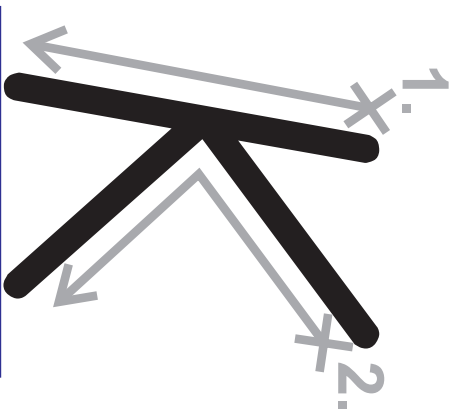
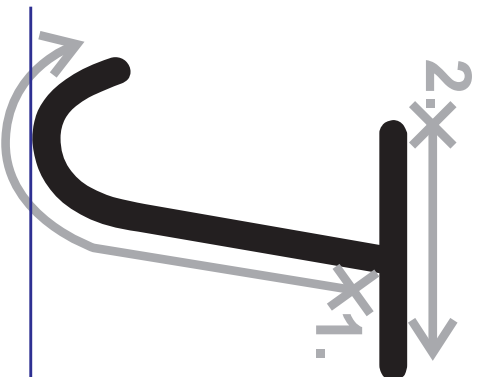
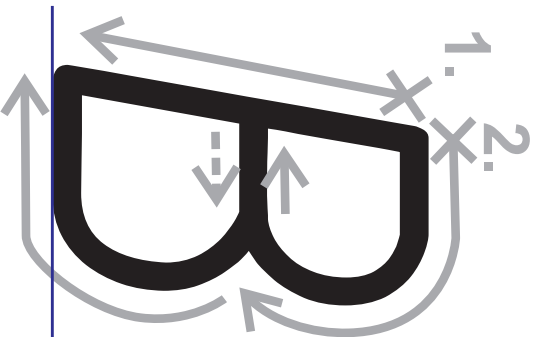
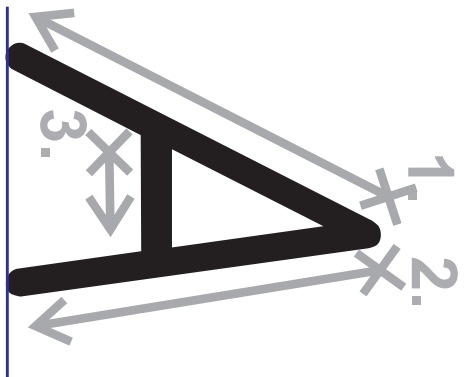

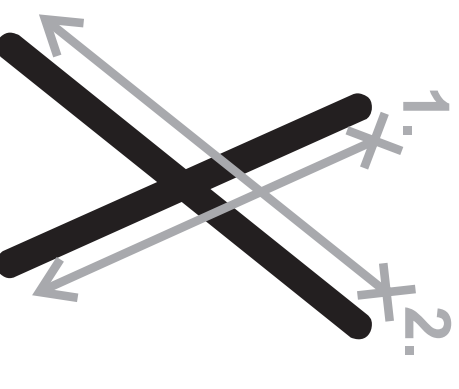
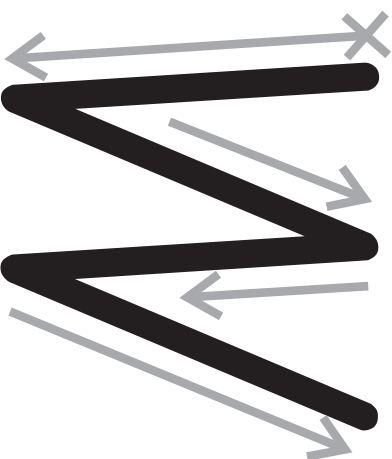
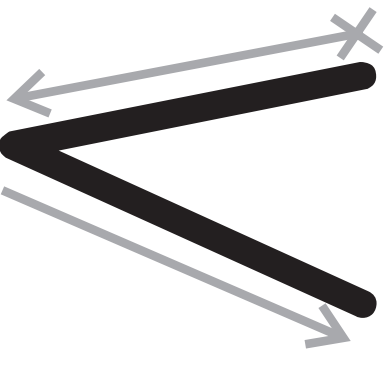
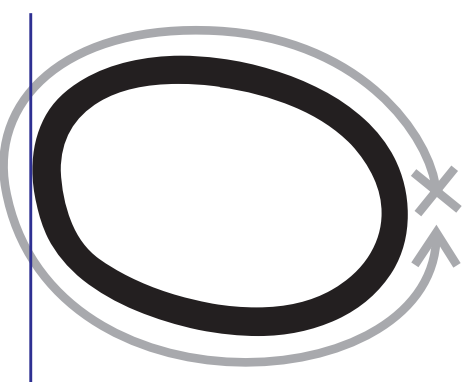
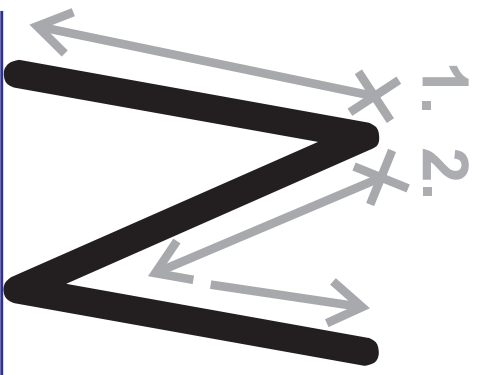
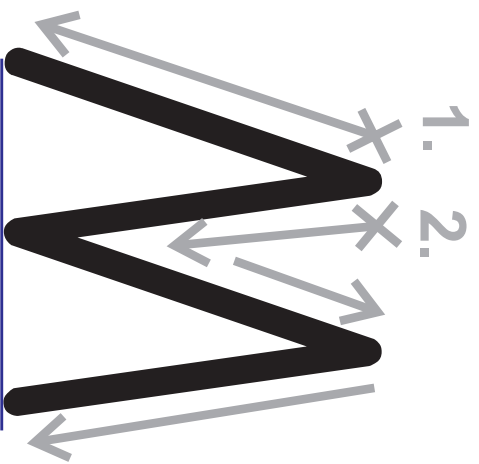
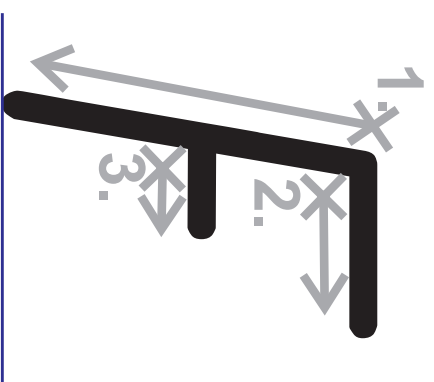
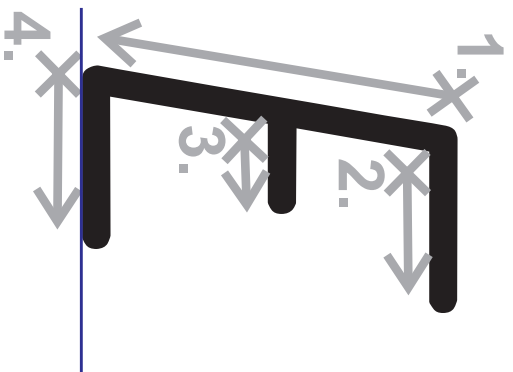
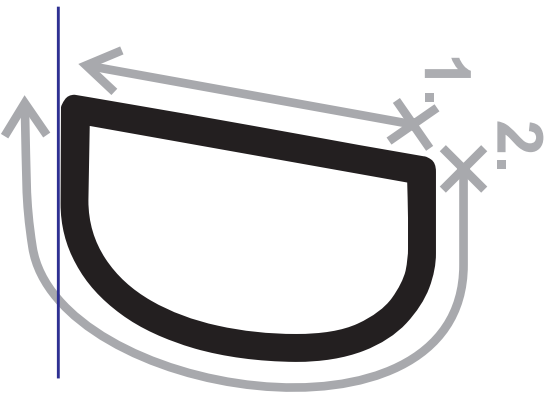

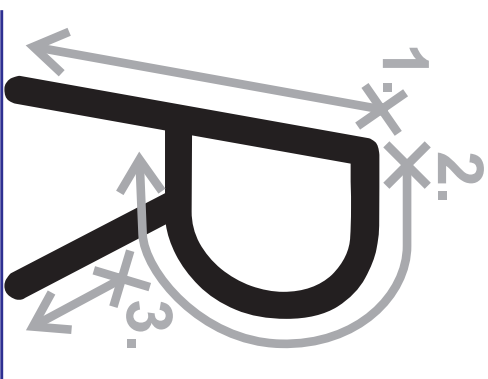
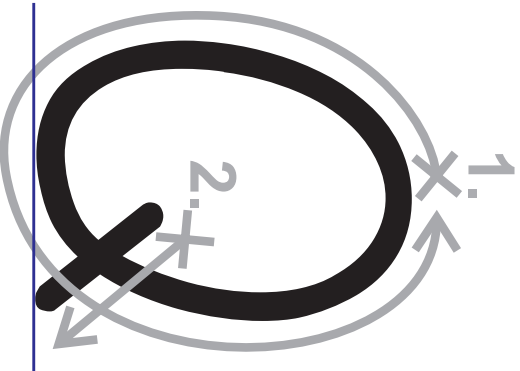
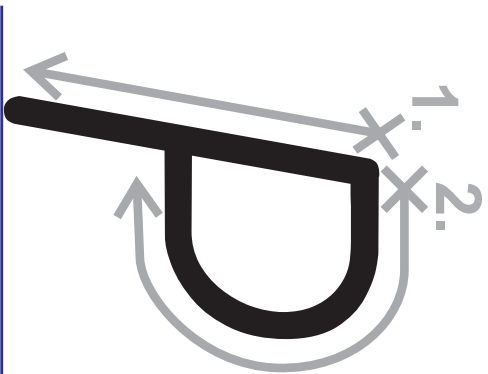
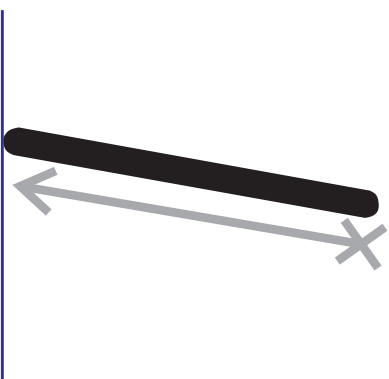
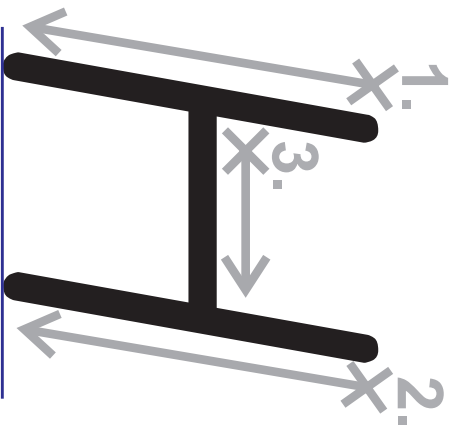
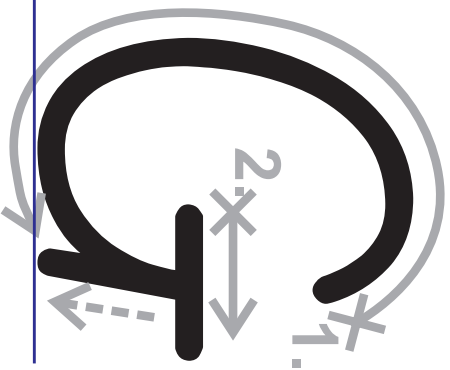

+

+

+

+

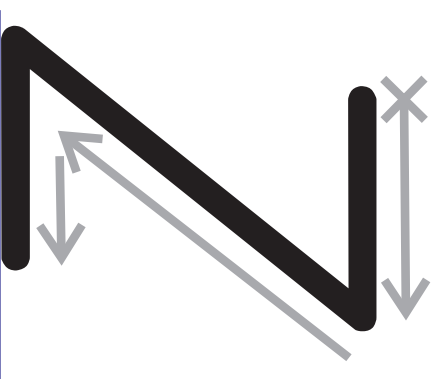
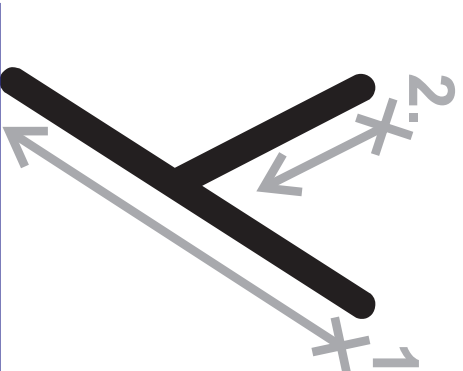

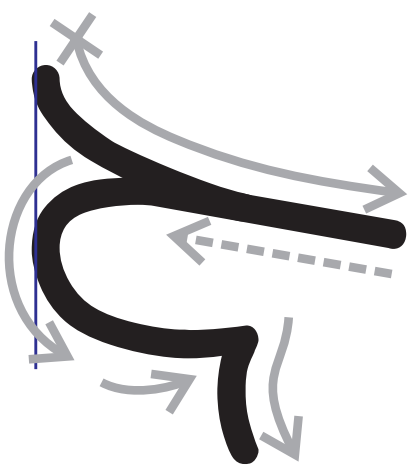
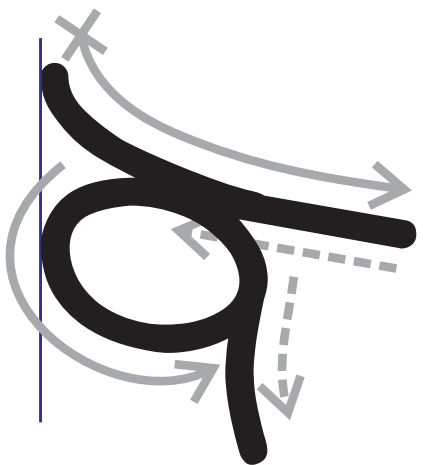
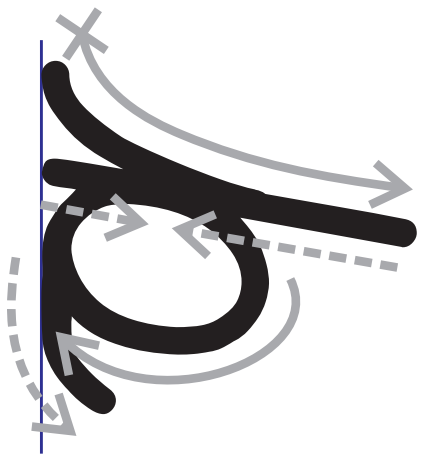
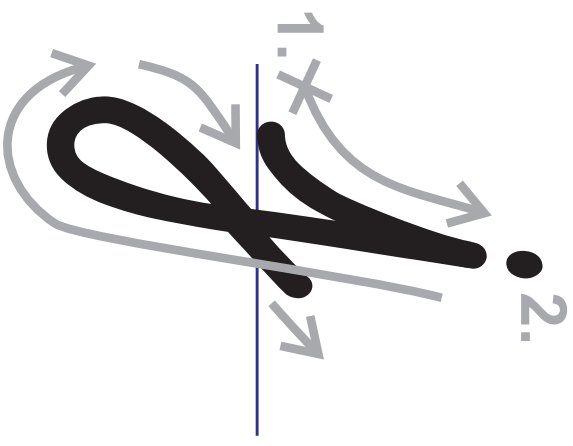
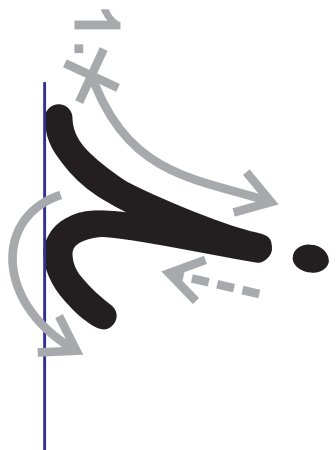
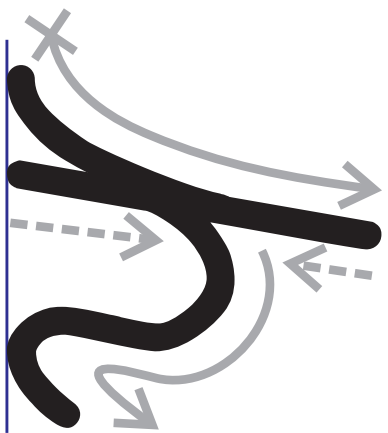
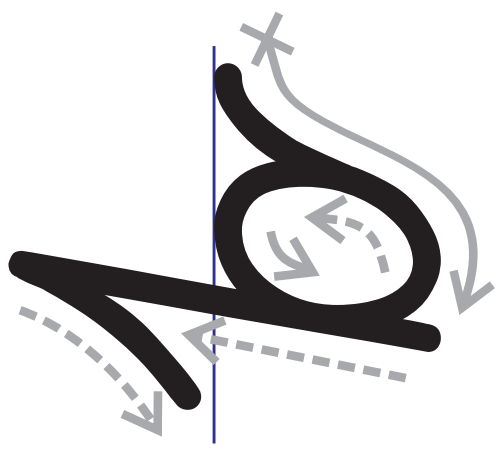
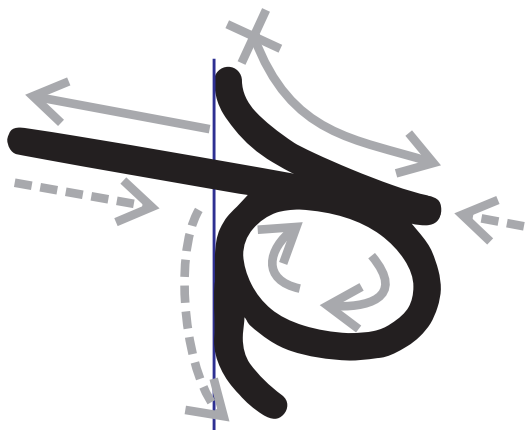
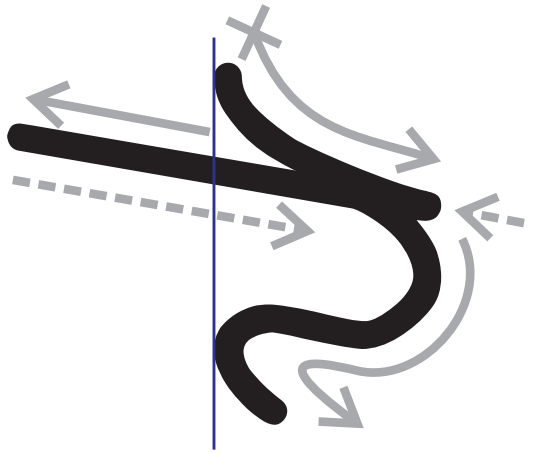

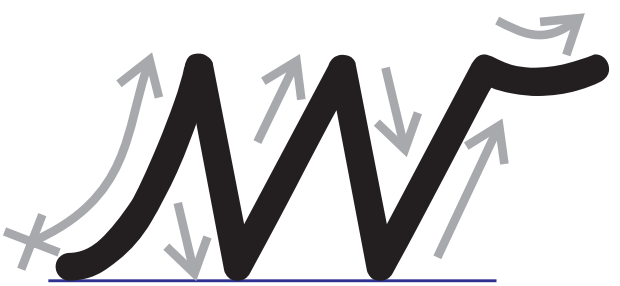
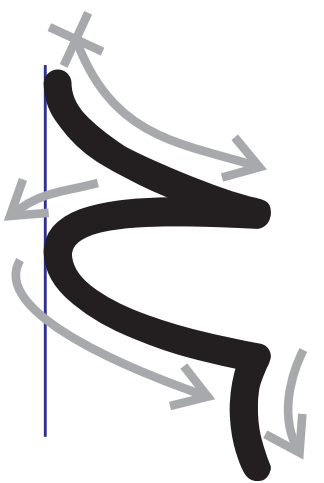
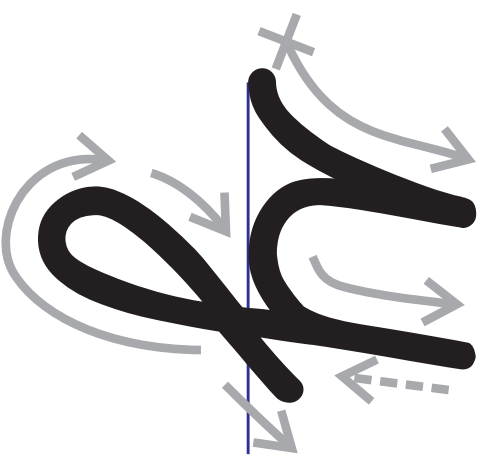
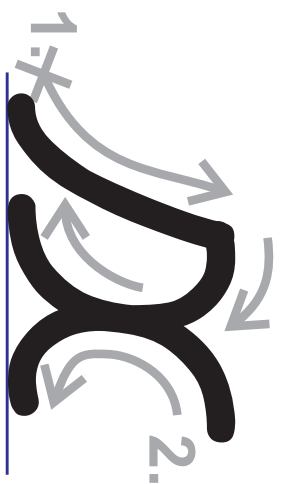
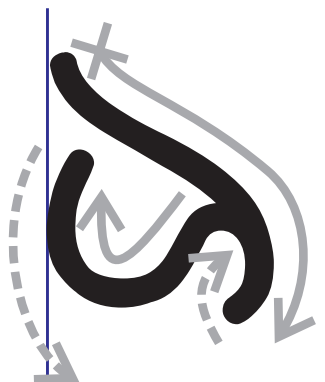
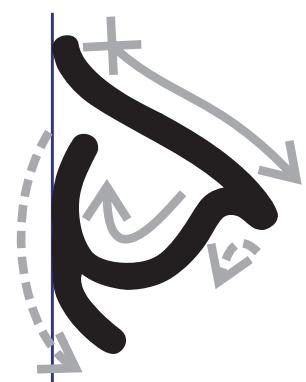
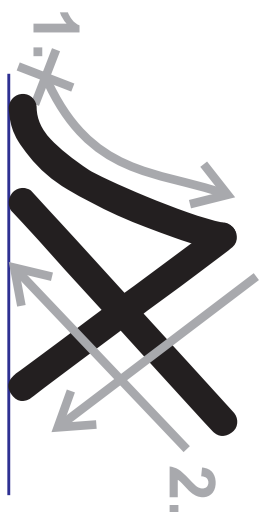
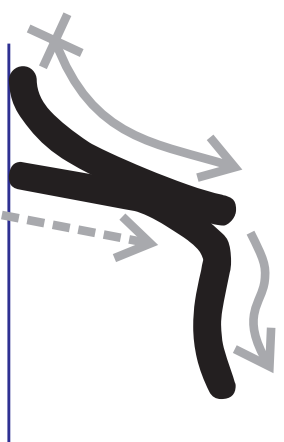

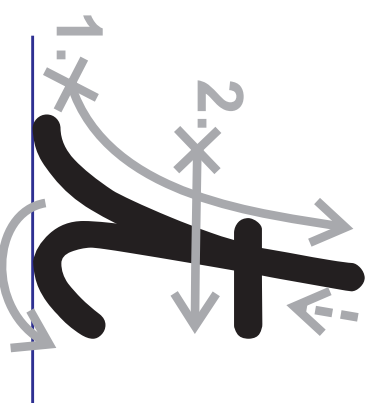
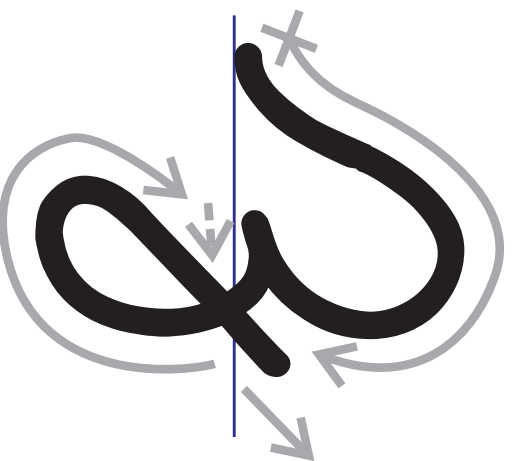
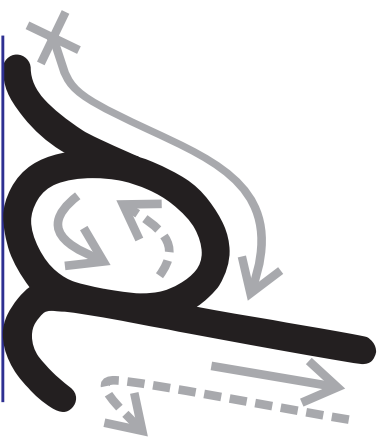
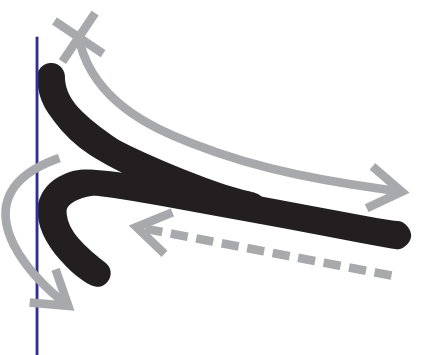
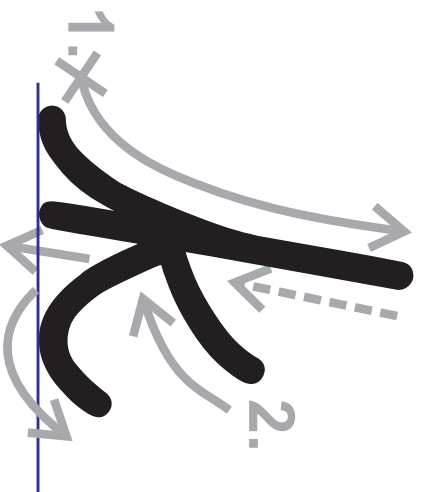
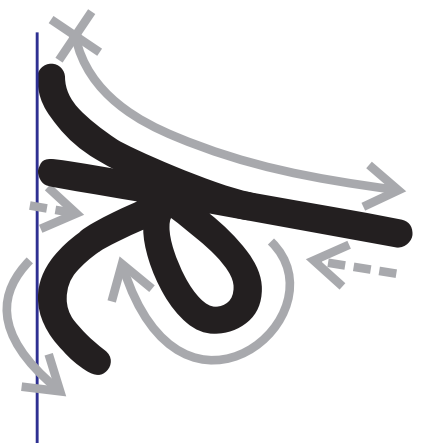
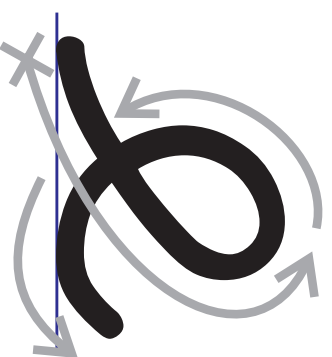
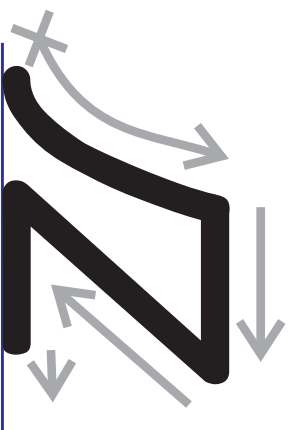
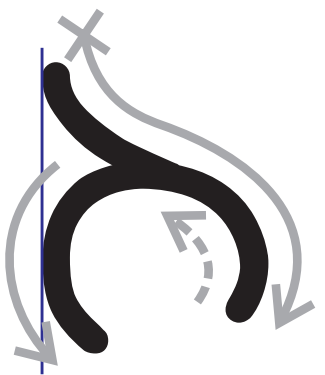

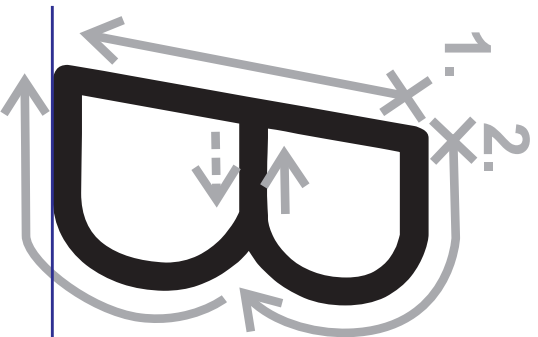
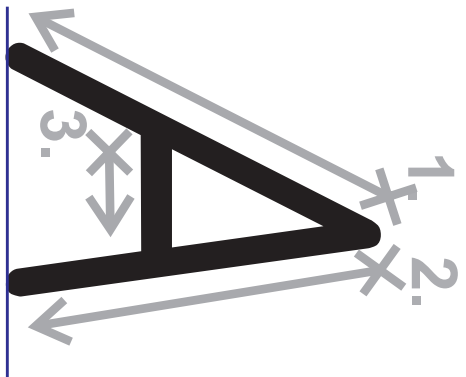

+

+

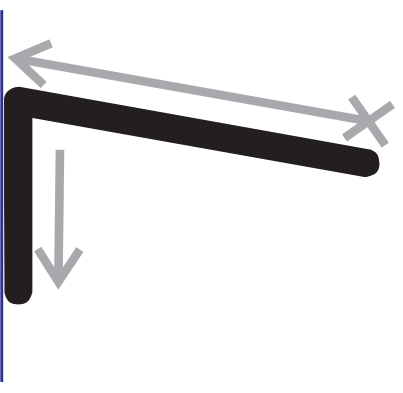
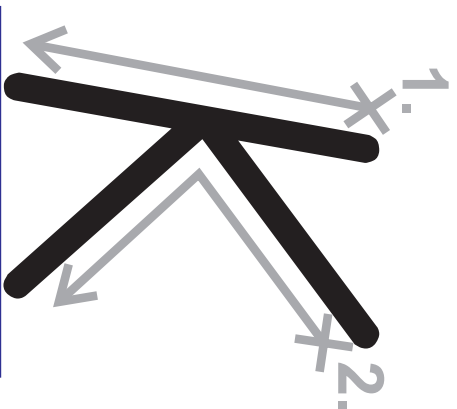

+

+

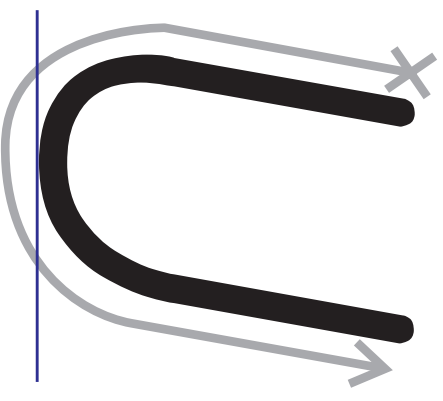
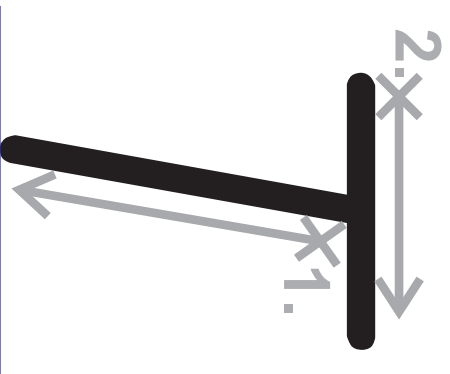
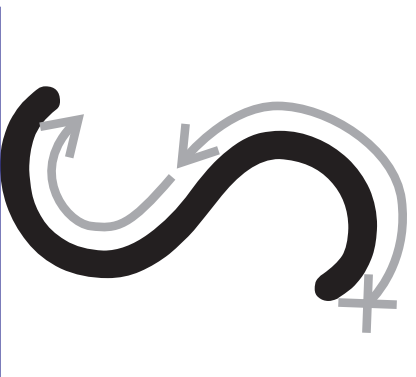

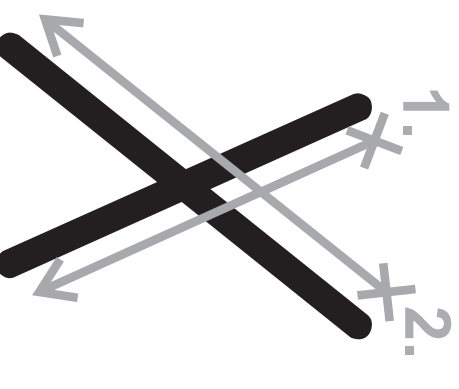
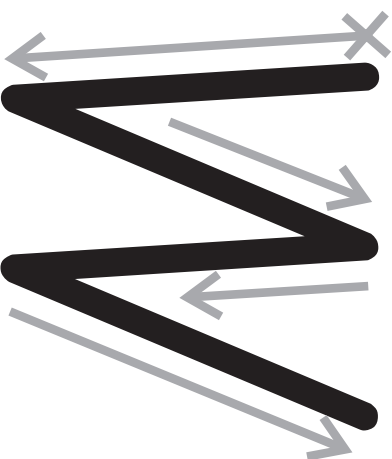
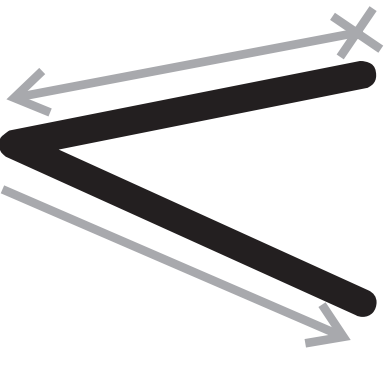
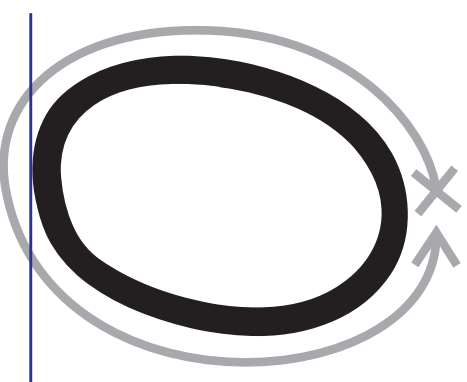
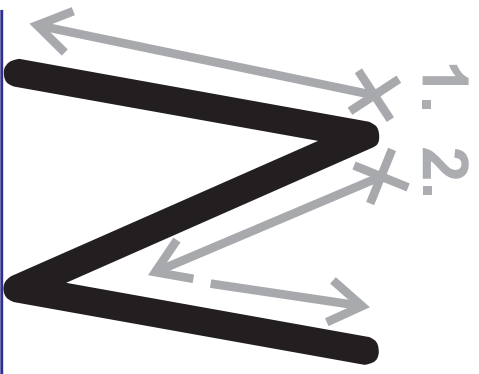
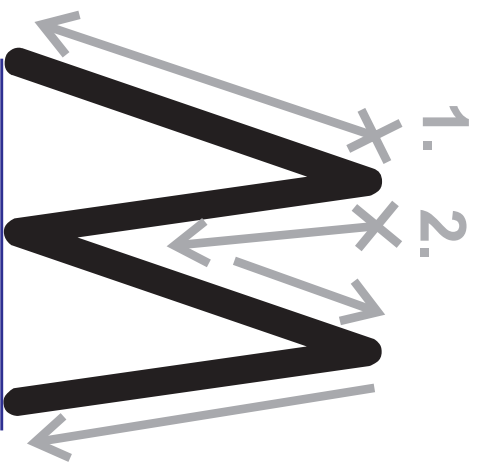
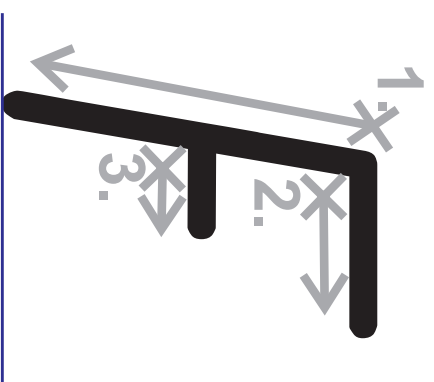
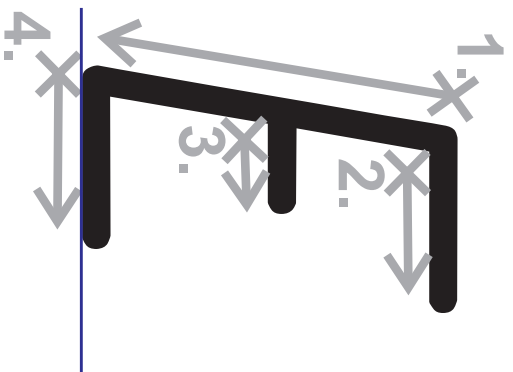
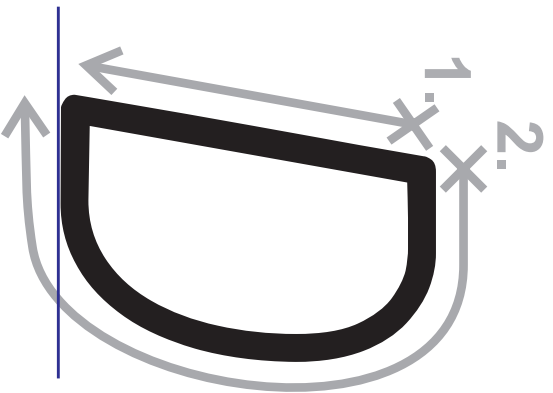

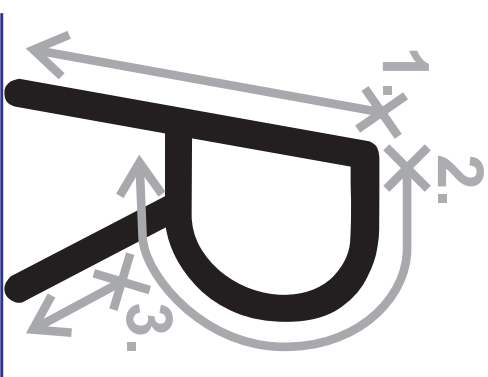
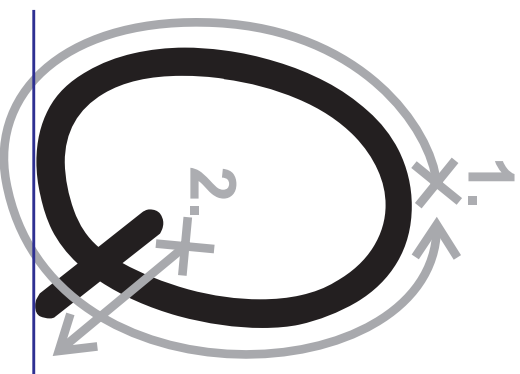
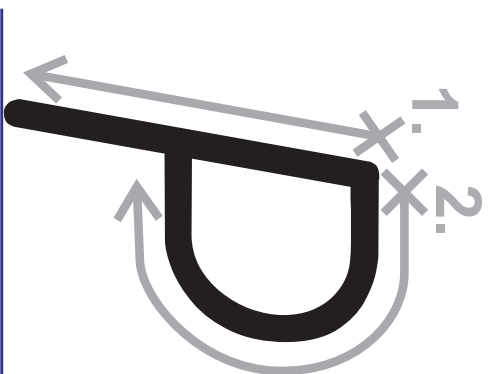
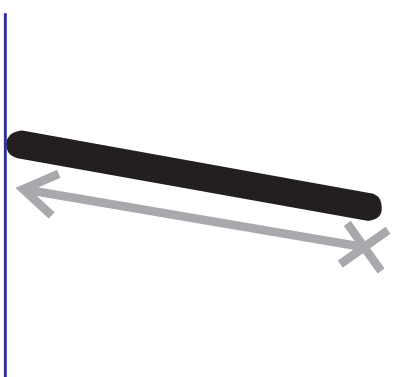
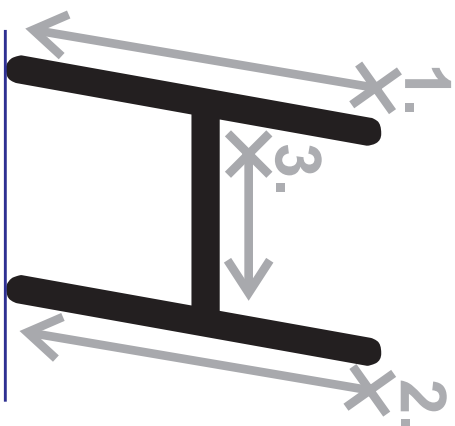
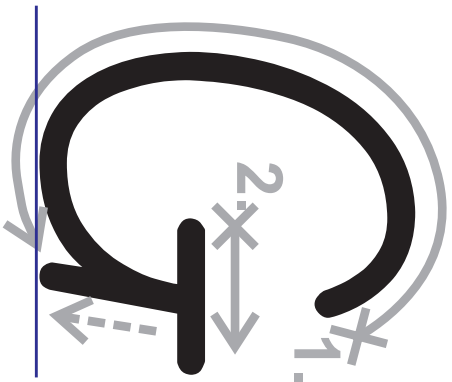

+

+

+

+

